

10GBASE-BX SFP+

1270nmTX/1330nmRX 10km

DOM Transceiver

SFP-10G-BX-LL



Application

- 10GBASE-LR at 10.3125Gbps
- 10GBASE-LW at 9.953Gbps
- OBSAI rates 6.144 Gb/s, 3.072 Gb/s, 1.536 Gb/s, 0.768Gb/s
- CPRI rates 9.830 Gb/s, 7.373Gb/s, 6.144 Gb/s, 4.915 Gb/s, 2.458 Gb/s, 1.229 Gb/s, 0.614Gb/s
- Other Optical Links

Features

- Operating data rate up to 11.3Gbps
- Two types:
 - A: 1270nm DFB Transmitter/ 1330nm Receiver
 - B: 1330nm DFB Transmitter/ 1270nm Receiver
- Power budget 9dB at least
- Single 3.3V Power supply and TTL Logic Interface
- LC Connector Interface
- Hot Pluggable
- Power Dissipation < 1.5W
- Built-in digital diagnostic functions, including optical power monitoring
- Commercial Temperature Range: 0~+70°C
- Compliant with SFP+ MSA Specification SFF-8431
- Compliant with IEEE 802.3ae 10GBASE-LR
- Compliant with IEEE 802.3ae 10GBASE-LW

Description

The SFP-10G-BX-LLseries single mode transceiver is small form factor plug module for duplex optical data communications such as 10GBASE-LR/LW defined by IEEE 802.3ae. It is with the SFP+ 20-pin connector to allow hot plug capability.

The SFP-10G-BX-LL module is designed for single mode fiber and operates at nominal wavelength of 1270nm; SFP-10G-BX-LL module is designed for single mode fiber and operates at a nominal wavelength of 1330nm. The transmitter section uses a multiple quantum well DFB, which is class 1 laser compliant according to International Safety Standard IEC-60825.

The receiver section uses an integrated InGaAs detector preamplifier (IDP) mounted in an optical header and a limiting post-amplifier IC.

Product Specifications

I. General Specifications

Parameter	Symbol	Min	Typ.	Max	Unit
Bit Rate	BR		10.3125	11.3168	Gb/s
Max. Supported Link Length	L_{max}			10	km

II. Absolute Maximum Ratings

Parameter	Symbol	Min	Max	Unit
Storage Temperature	T_s	-40	+85	° C
Supply Voltage	Vcc	-0.5	3.6	V

III. Electrical Characteristics

Parameter	Symbol	Min	Typ.	Max	Unit	Ref.
Power Supply Voltage	V _{cc}	3.15	3.3	3.45	V	
Power Supply Current	I _{cc}			430	mA	
Surge Current	I _{surge}			+30	mA	
Transmitter						
CML Inputs (Differential)	V _{in}	150		1200	mVpp	AC coupled inputs
Input Impedance (Differential)	Z _{in}	85	100	115	ohms	R _{in} > 100 kohms @ DC
Tx_DISABLE Input Voltage – High		2		V _{cc} +0.3	V	
Tx_DISABLE Input Voltage – Low		0		0.8	V	
Tx_FAULT Output Voltage – High		2		V _{cc} +0.3	V	I _o = 400µA; Host V _{cc}
Tx_FAULT Output Voltage – Low		0		0.5	C	I _o = -4.0Ma
Receiver						
CML Outputs (Differential)	V _{out}	350		700	mVpp	AC coupled outputs
Output Impedance (Differential)	Z _{out}	85	100	115	ohms	
Rx_LOS Output Voltage – High		2		V _{cc} +0.3	V	I _o = 400µA; Host V _{cc}
Rx_LOS Output Voltage – Low		0		0.8		I _o = -4.0Ma
MOD_DEF (2:0)	V _{oH}	2.5			V	With Serial ID
	V _{oL}	0		0.5	V	

IV. Optical Characteristics

(1270nm DFB & PIN/TIA)

Parameter	Symbol	Min	Typ.	Max	Unit
Power Budget		9			dB
Data Rate		0.6	10.3125	11.3	Gbps
Transmitter (Tx)					
Centre Wavelength	λ_c	1260	1270	1280	nm
Spectral Width (-20Db)	$\Delta\lambda$			1	nm
Side Mode Suppression Ratio	SMSR	30			dB
Average Output Power*note1	$P_{out, AVG}$	-8.2		0.5	dBm
Extinction Ratio	ER	3.5			dB
Average Power of OFF Transmitter				-30	dB
Average Power of OFF Transmitter	RIN			-128	dB/Hz
TX Disable Assert Time	t_{off}			10	us
Receiver (Rx)					
Centre Wavelength	λ_c	1320		1340	nm
Sensitivity*note2	P_{IN}			-14.4	dBm
Receiver Overload	P_{MAX}	0.5			dBm
LOS De-Assert	LOS_D			-18	dBm
LOS Assert	LOS_A	-30			dBm

(1330nm DFB & PIN/TIA)

Parameter	Symbol	Min	Typ.	Max	Unit
Power Budget		9			dB
Data Rate		0.6	10.3125	11.3	Gbps
Transmitter (Tx)					
Centre Wavelength	λ_C	1320	1330	1340	nm
Spectral Width (-20Db)	$\Delta\lambda$			1	nm
Side Mode Suppression Ratio	SMSR	30			dB
Average Output Power*note1	$P_{out, AVG}$	-8.2		0.5	dBm
Extinction Ratio	ER	3.5			dB
Average Power of OFF Transmitter				-30	dB
Average Power of OFF Transmitter	RIN			-128	dB/Hz
TX Disable Assert Time	t_{off}			10	us
Receiver (Rx)					
Centre Wavelength	λ_C	1320		1280	nm
Sensitivity*note2	P_{IN}			-14.4	dBm
Receiver Overload	P_{MAX}	0.5			dBm
LOS De-Assert	LOS_D			-18	dBm
LOS Assert	LOS_A	-30			dBm

Notes:

1. Output is coupled into a 9/125um SMF.
2. Measured with worst ER, BER less than 1E-12 and PRBS 231-1 at 10.3125Gbps..

V. Pin Description

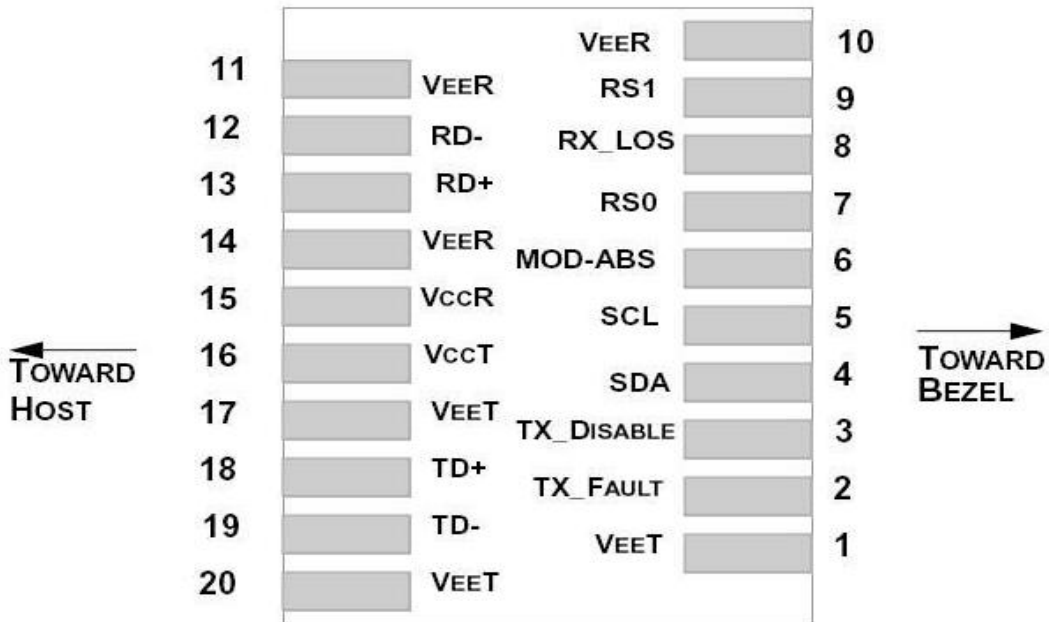

Pin Num.	Name	Function	Plug Seq.	Notes
1	VeeT	Transmitter Ground	1	Note 5
2	TX Fault	Transmitter Fault Indication	3	Note 1
3	TX Disable	Transmitter Disable	3	2, Module disables on high or open
4	SDA	Module Definition 2	3	2-wire Serial Interface Data Line.
5	SCL	Module Definition 1	3	2-wire Serial Interface Clock.
6	MOD_ABS	Module Definition 0	3	Note 3
7	RS0	RX Rate Select (LVTTTL).	3	Rate Select 0, optionally controls SFP+ module receiver. This pin is pulled low to VeeT with a >30K resistor..
8	LOS	Loss of Signal	3	Note 4
9	RS1	TX Rate Select (LVTTTL).	1	Rate Select 1, optionally controls SFP+ module transmitter. This pin is pulled low to VeeT with a >30K resistor.

10	VeeR	Receiver Ground	1	Note 5
11	VeeR	Receiver Ground	1	Note 5
12	RD-	Inv. Received Data Out	3	Note 6
13	RD+	Received Data Out	3	Note 6
14	VeeR	Receiver Ground	1	Note 5
15	VeeR	Receiver Power	2	3.3V \pm 5%, Note 7
16	VccT	Transmitter Power	2	3.3V \pm 5%, Note 7
17	VeeT	Transmitter Ground	1	Note 5
18	TD+	Transmit Data In	3	Note 8
19	TD-	Inv. Transmit Data In	3	Note 8
20	VeeT	Transmitter Ground	1	Note 5

Notes:

- TX Fault is an open collector/drain output, which should be pulled up with a 4.7K – 10K Ω resistor on the host board. Pull up voltage between 2.0V and VccT/R+0.3V. When high, output indicates a laser fault of some kind. Low indicates normal operation. In the low state, the output will be pulled to <0.8V.
- TX disable is an input that is used to shut down the transmitter optical output. It is pulled up within the module with a 4.7K – 10 K Ω resistor. Its states are: Low (0 – 0.8V): Transmitter on (>0.8, < 2.0V): Undefined High (2.0 – 3.465V): Transmitter Disabled Open: Transmitter Disabled
- Module Absent, connected to VeeT or VeeR in the module.
- LOS (Loss of Signal) is an open collector/drain output, which should be pulled up with a 4.7K – 10K Ω resistor. Pull up voltage between 2.0V and VccT/R+0.3V. When high, this output indicates the received optical power is below the worst- case receiver sensitivity (as defined by the standard in use). Low indicates normal operation. In the low state, the output will be pulled to < 0.8V.
- The module signal ground contacts, VeeR and VeeT, should be isolated from the module case.
- RD-/+ : These are the differential receiver outputs. They are AC coupled 100 Ω differential lines which should be terminated with 100 Ω (differential) at the user SERDES. The AC coupling is done inside the module and is thus not required on the host board. The voltage swing on these lines will be between 350 and 700 Mv differential (175–350 Mv single ended) when properly terminated.

7. VccR and VccT are the receiver and transmitter power supplies. They are defined as $3.3V \pm 5\%$ at the SFP+ connector pin. Maximum supply current is 300Ma. Recommended host board power supply filtering is shown below. Inductors with DC resistance of less than 1 ohm should be used in order to maintain the required voltage at the SFP+ input pin with 3.3V supply voltage. When the recommended supply- filtering network is used, hot plugging of the SFP+ transceiver module will result in an inrush current of no more than 30Ma greater than the steady state value. VccR and VccT may be internally connected within the SFP+ transceiver module.

8. TD-/+: These are the differential transmitter inputs. They are AC-coupled, differential lines with 100Ω differential termination inside the module. The AC coupling is done inside the module and is thus not required on the host board. The inputs will accept differential swings of 150 – 1200 Mv (75 –600Mv single-ended).

EEPROM :

The serial interface uses the 2-wire serial CMOS EEPROM protocol defined for the ATMEL AT24C02/04 family of components. When the serial protocol is activated, the host generates the serial clock signal (SCL). The positive edge clocks data into those segments of the EEPROM that are not writing protected within the SFP+ transceiver. The negative edge clocks data from the SFP+ transceiver. The serial data signal (SDA) is bi-directional for serial data transfer. The host uses SDA in conjunction with SCL to mark the start and end of serial protocol activation. The memories are organized as a series of 8-bit data words that can be addressed individually or sequentially.

The Module provides diagnostic information about the present operating conditions. The transceiver generates this diagnostic data by digitization of internal analog signals. Calibration and alarm/warning threshold data is written during device manufacture. Received power monitoring, transmitted power monitoring, bias current monitoring, supply voltage monitoring and temperature monitoring all are implemented. If the module is defined as external calibrated, the diagnostic data are raw A/D values and must beconverted to real world units using calibration constants stored in EEPROM locations 56 – 95 at wire serial bus address A2h. The digital diagnosticmemory map specific data field define as following. For detail EEPROM information, please refer to the related document of SFF 8472 Rev 10.2.

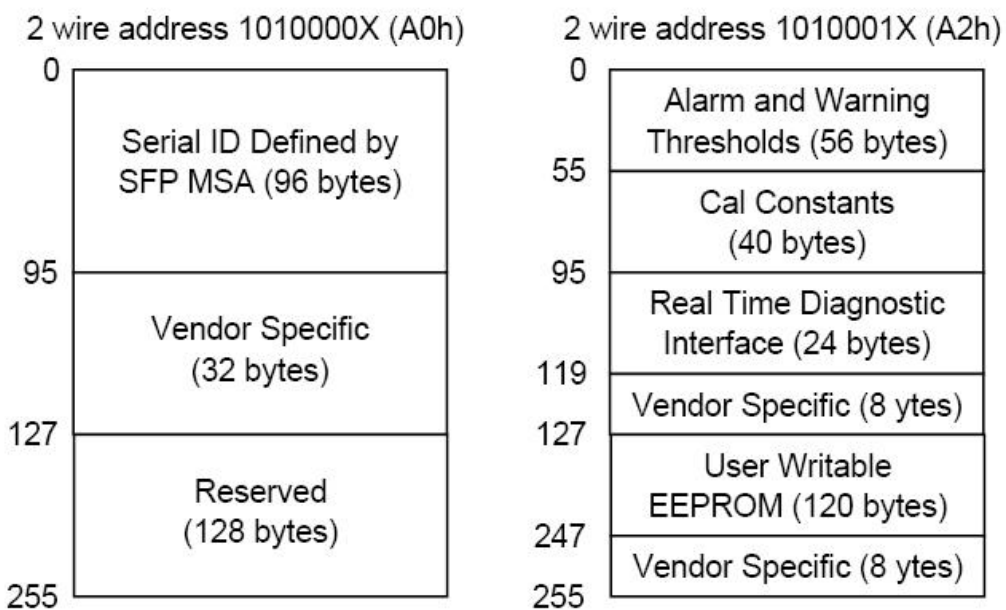

VI. Recommend Circuit Schematic

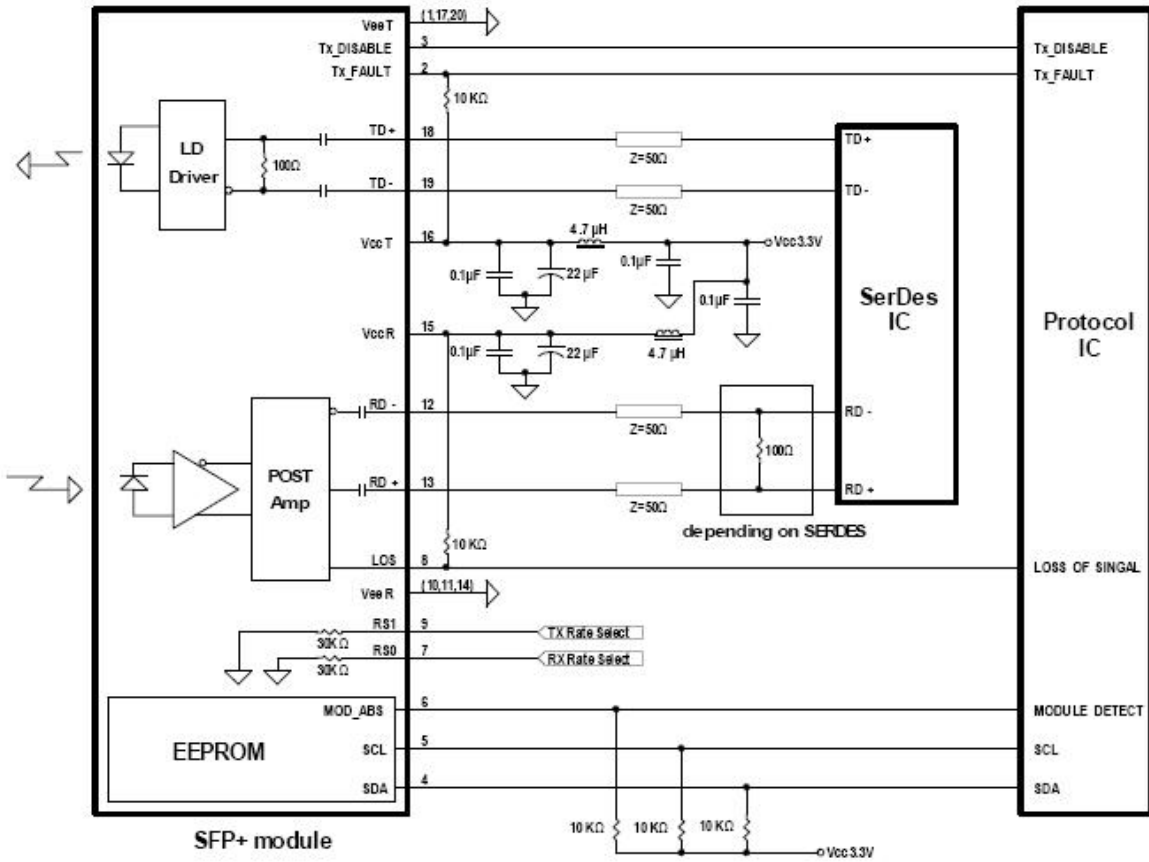

VII. Mechanical Specifications

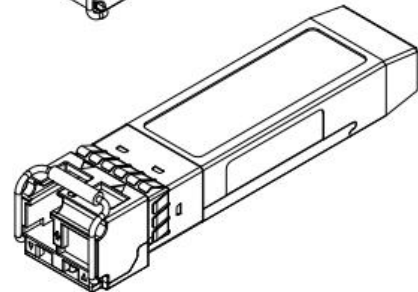
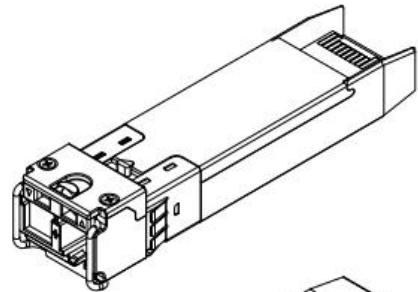
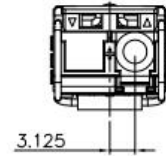
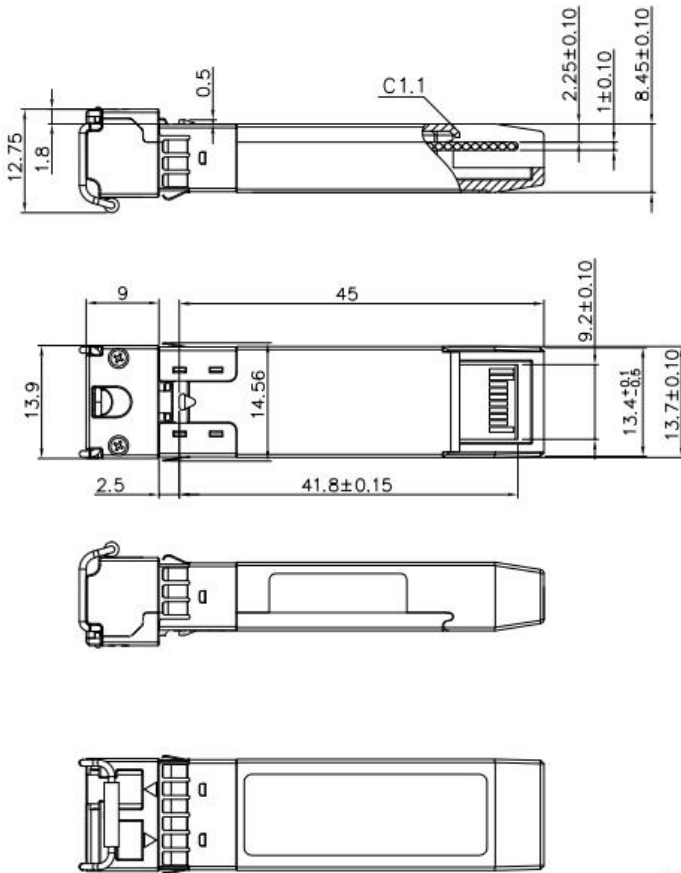

Unremarked tolerances ±0.2mm